

COMPOSITE SALES

PART OF THE PBSL GROUP



COMPOSITE DECKING

INSTALLATION GUIDE



WELCOME TO OUR INSTALLATION GUIDE

Our range of robust double faced, wood plastic composite (WPC) decking boards is a beautiful long lasting alternative to wood.

The planks are sold in 3.66 metre lengths and stocked in three different wood-grain styles. This WPC solution to decking is virtually maintenance-free and environmentally friendly. The composite boards are perfect for homes, parks, and camping sites as they provide both security and longevity.

The installation of these products can be done at any time of the year, though we would recommend installing during spring.



LOW MAINTENANCE



NO ROTTING, SPLINTERING OR WARPING



10-YEAR GUARANTEE



NO ALGAE GROWTH



ENVIRONMENTALLY FRIENDLY



The Board

Made from a Wood Plastic Composite, our honeycomb hollow core composite decking boards have a lightweight construction and are reversible with narrow spaced grooves on one side and woodgrain on the other.

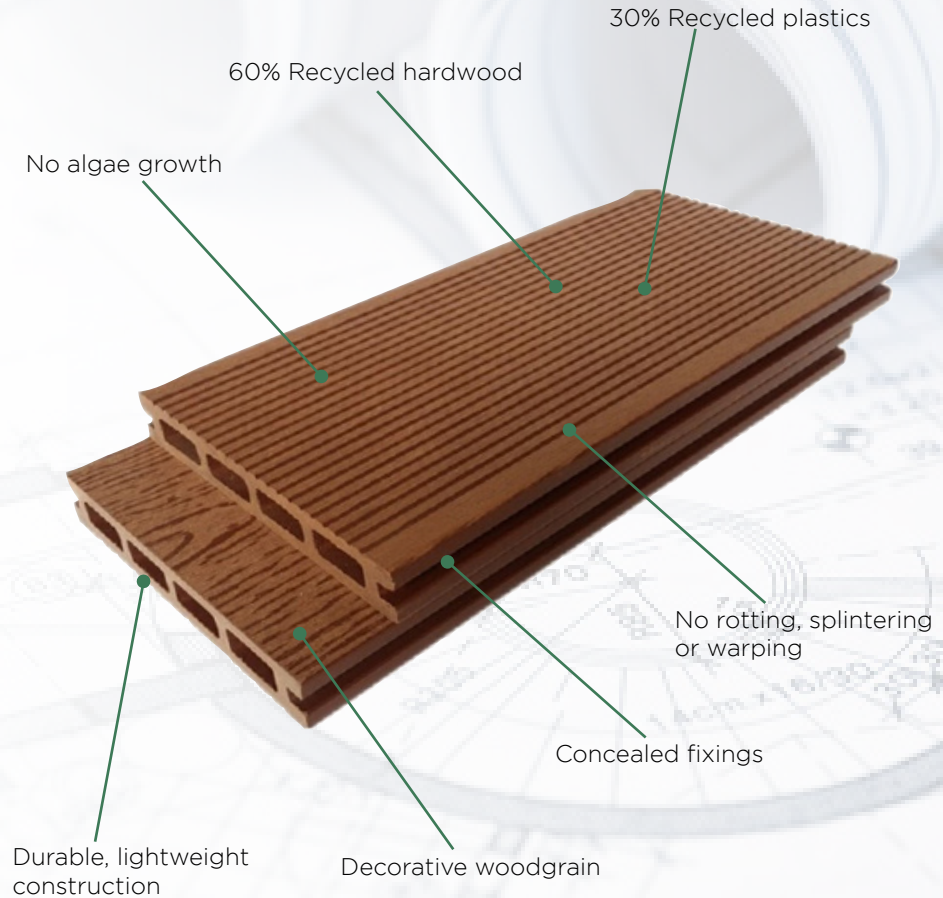

- Each board is 146mm wide x 22mm thick x 3.66mtr long
- Please note that images are used for illustration purposes only. The actual product may slightly vary from the image supplied.
- **We recommend installing WPC decking on WPC keels and PVC pedestals.**



Accessories

1

Composite keels, sometimes known as “subframe”, are available in 2 standard sizes 40 x 30mm x 3.6m and 61 x 41mm x 3.6mtr. Composite keels are non-structural and must only be used in conjunction with pedestal. They should be laid on a solid flat, stable surface, such as concrete base.

A drainage slope of 0.5% or 5mm per metre is required to ensure sufficient water run-off.

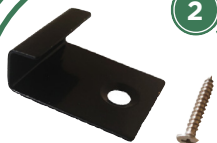
2

Stainless steel starter clips should be used for securing the first line and the last line of decking boards with a minimum spacing of 300mm centres (13 clips per length).

When butt jointed to walls, or other fixed objects, a 20mm gap is required.

3

Our composite decking must have a 6mm gap between each board, and must be fitted using our stainless steel deck clips and screws.

A minimum spacing of 300mm centres (13 clips per length) is recommended.

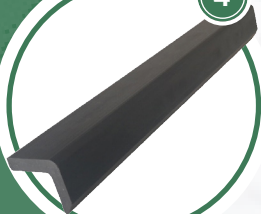
4

Edge trims

Our side cover angle - 40mm x 36mm x 3.66mtr is used to make a nice clean finish on your decking.

The WPC solid fascia plank - 144mm x 11mm x 3.66mtr is used to make a nice clean finish on visible decking faces.

This two-tone double-sided fascia plank comes in flat sanded on one side and ribbed on the other.

Before you start

Allow the composite decking to acclimatise for a minimum of 3 days prior to installation. It should be stored flat, supported every 500mm (approximately 100mm to 150mm off the ground) under cover in shade, and protected from weather until ready to be installed.

We strongly recommend that the installation conditions are stable and flat to avoid the possibility of deforming the decking surface.

Preparing the area

Composite keels should be used with pedestal and be laid on a solid flat, stable surface, such as concrete base.

Unstable or uneven substrates such as grass, loose paving slabs, or sand will cause movement and damage the installation.

It is recommended that you do not fix composite keels directly to foundations. The decking joist centres should be no greater than 300mm, except when fitting composite decking boards on the diagonal, where we recommend that joist centres are 250mm and you work from the centre out.

Handling

Decking materials should be carefully stacked and not dumped when unloading to avoid damage. Do not slide composite decking boards over one another. During installation, avoid sliding or dragging any tools or other building materials across the board surface to prevent tarnishing.

We recommend that our composite decking is carried supporting the centre and their edge for best support when moving.

Safety

Personal protection equipment (PPE) should be worn at all times when installing composite decking.

We recommend to wear gloves, protective eye wear, and a dust mask.





Allow the composite decking to acclimatise for a minimum of 3 days prior to installation.



STEP 1 Determine how you are going to lay out your decking. Lay a suitable geotextile membrane & position the pedestals and keels.

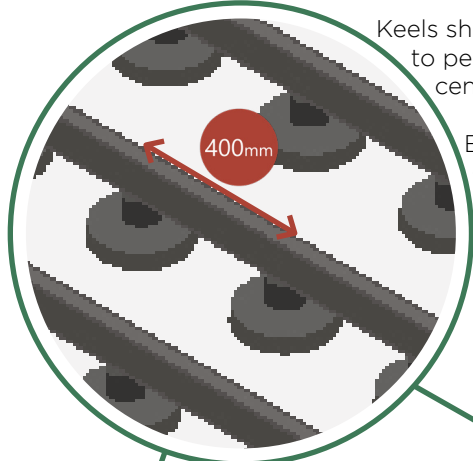

Keels should be supported / fixed to pedestals at the following centres:

Every 400mm when using 61mm x 41mm keel.

Every 350mm when using 40mm x 30mm keel.



• Geotextile Membrane.

- Not recommended for use where the space is walled in on all four sides.

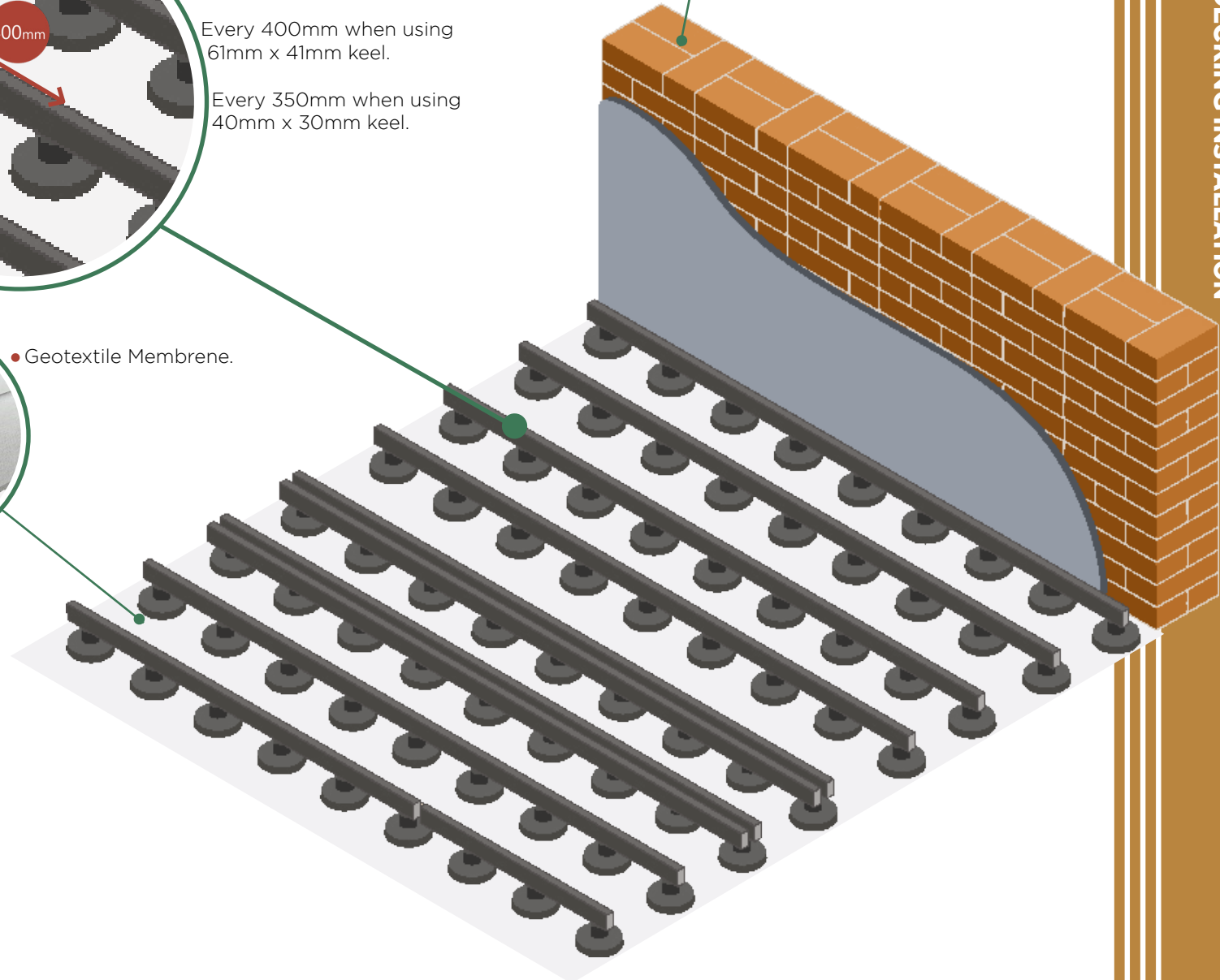

A drainage slope of 0.5% or 5mm per metre is required to ensure sufficient water run-off.

Allow 10mm gap if the decking is running parallel to the wall.

It is recommended that you do not screw directly to composite decking or its keel. We, instead, suggest a 1mm pilot hole to avoid splitting.



STEP 2 Composite decking should be supported / fixed at 300mm centres

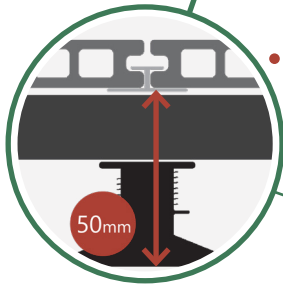
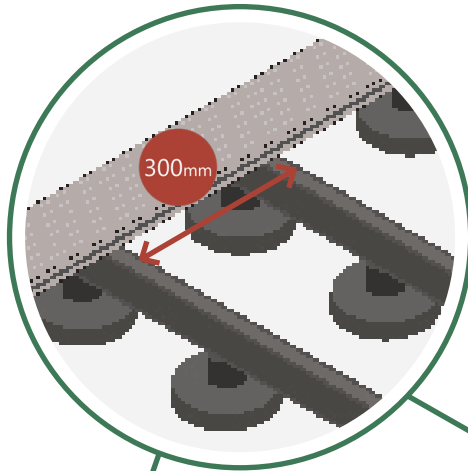

- Decking boards should be a minimum of 50mm off the ground.

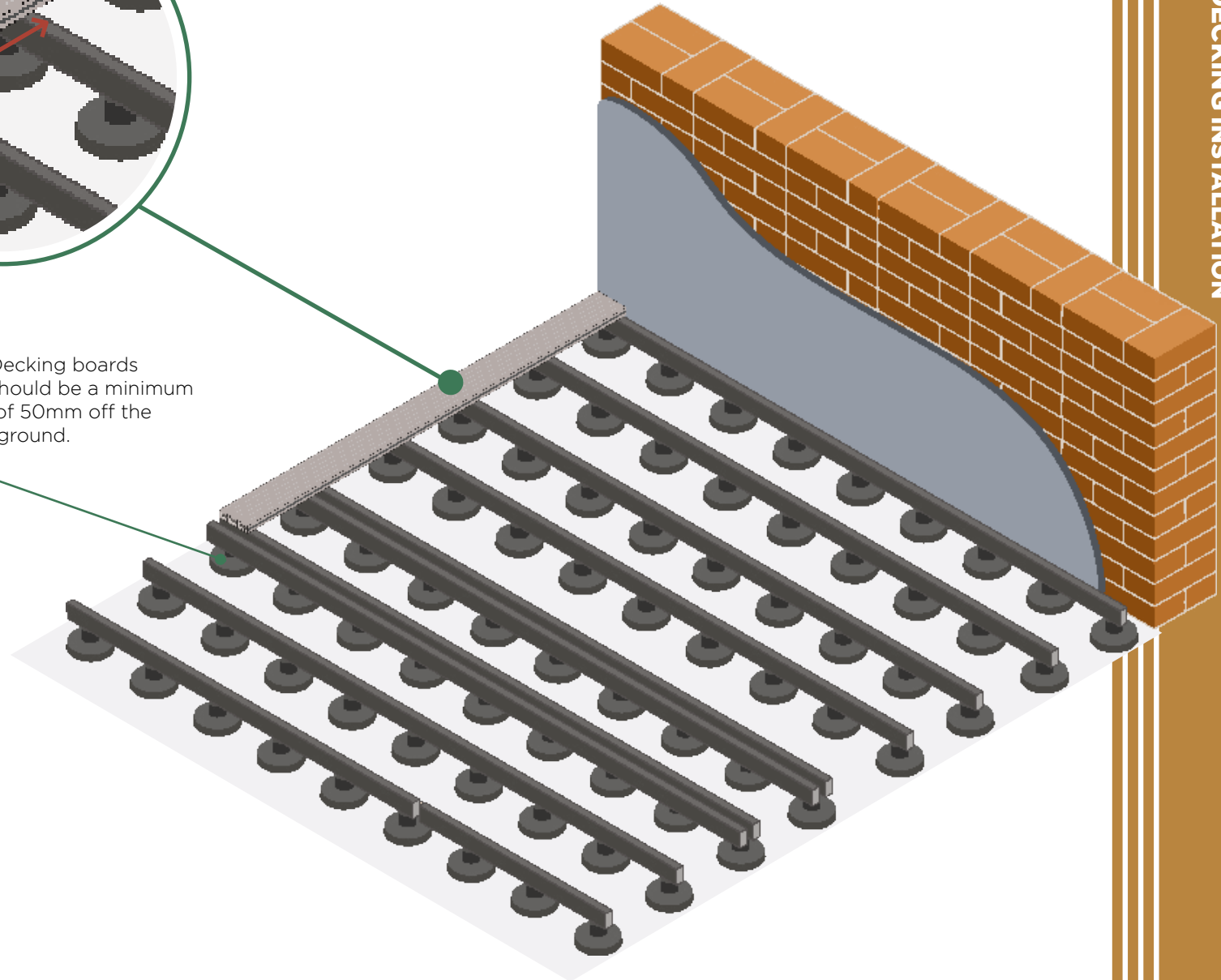

It is recommended that you do not screw directly to composite decking or its keel. We instead suggest a 1mm pilot hole to avoid splitting.



STEP 3 When two keels meet a 15mm expansion gap should be left

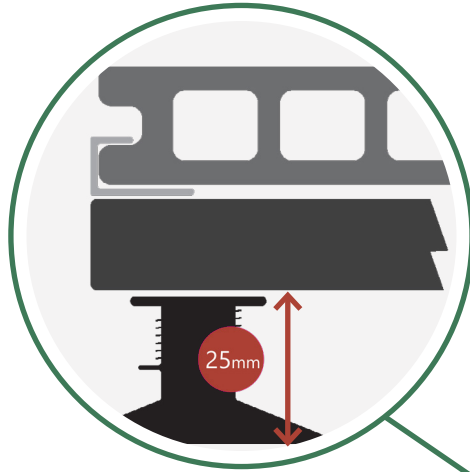

STEP 4 Keel must be raised a minimum of 25mm above a solid base.

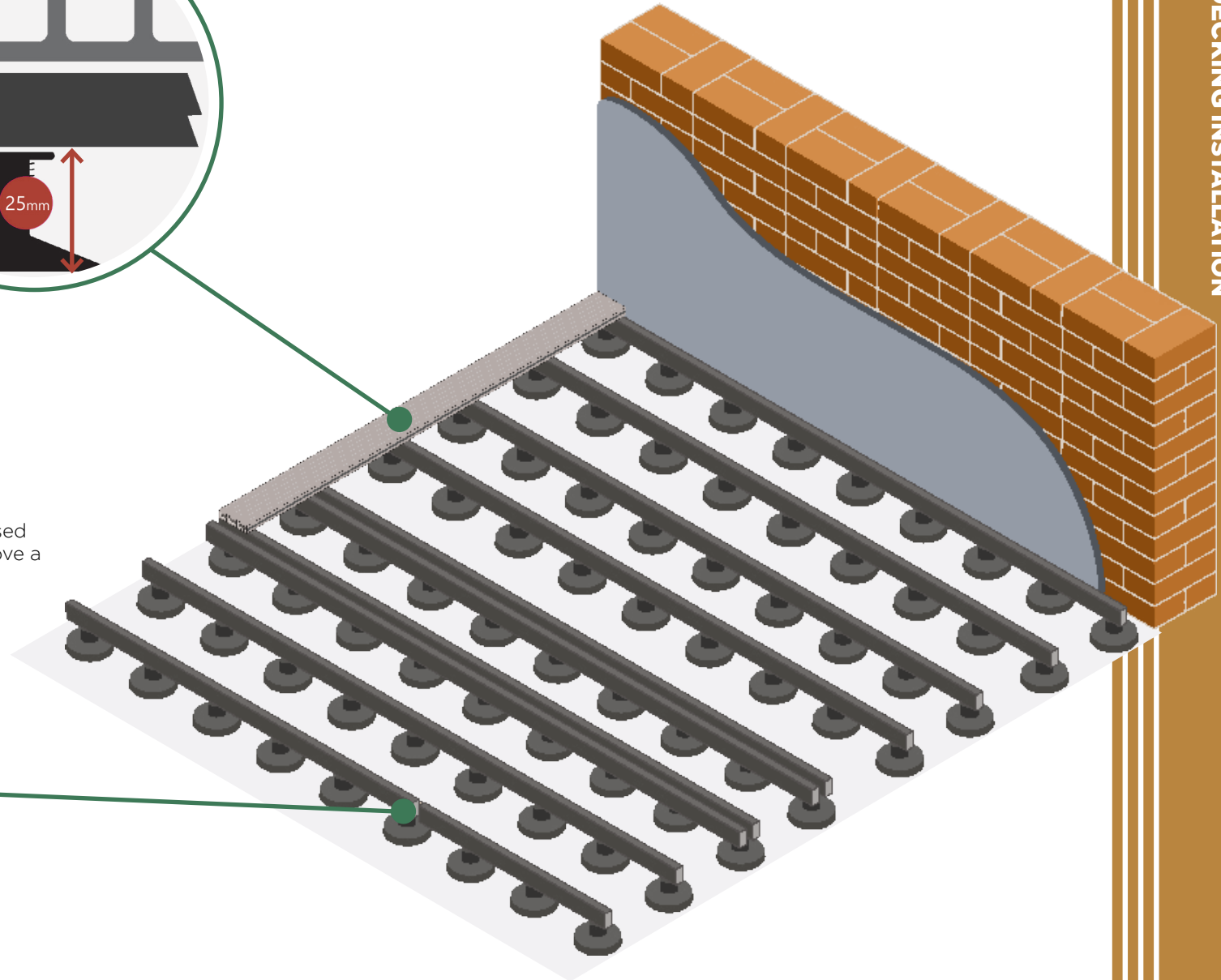
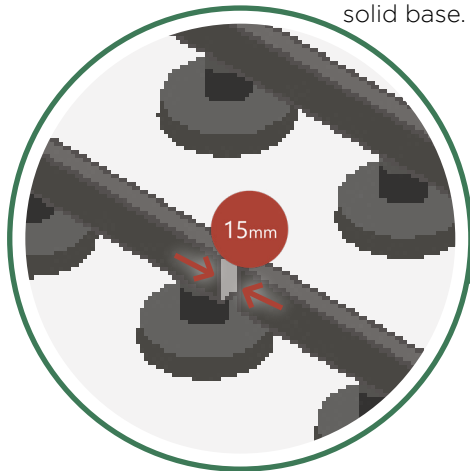



STEP 5 Determine how you are going to lay out your decking. Lay a suitable geotextile membrane & position the pedestals and keels.

Provide a minimum 20mm gap between the edge of decking and any adjacent wall.

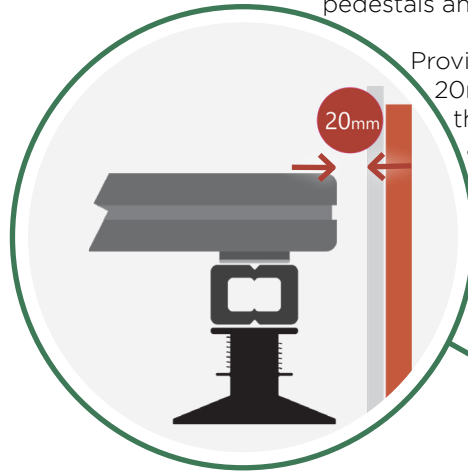

STEP 6 Fix stainless steel starter clips at 300mm maximum joist centres (250mm for diagonal installation), using 3mm x 25mm stainless steel screws.

There should be a 10mm maximum board end overhang from the keel.

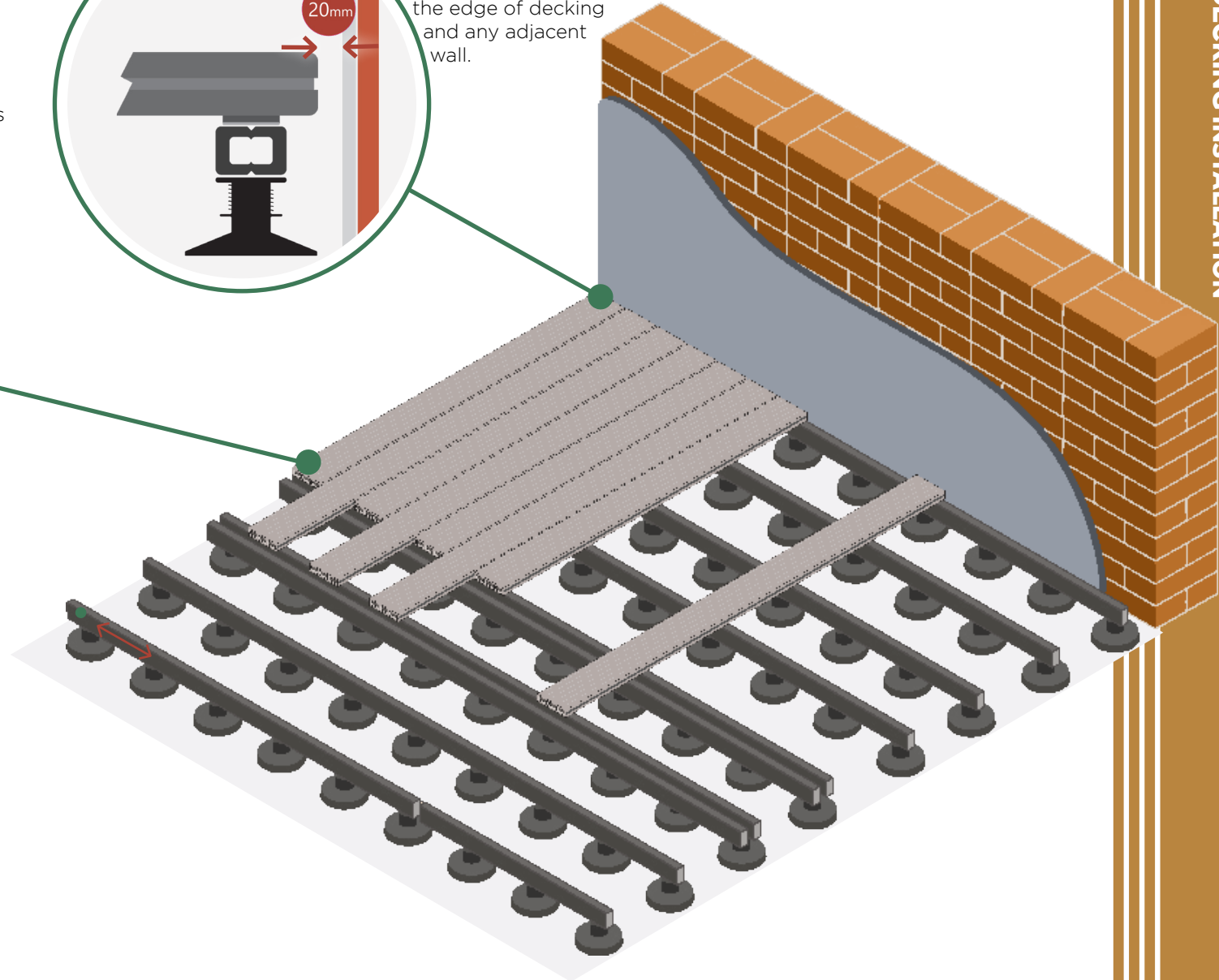
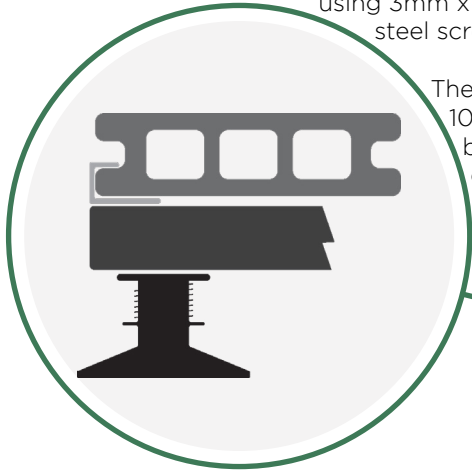

It is recommended that you do not screw directly to composite decking or its keel. We instead suggest a 1mm pilot hole to avoid splitting.



It is recommended that you do not screw directly to composite decking or its keel. We instead suggest a 1mm pilot hole to avoid splitting.

STEP 7 Install two keels under the butt joints, with one clip each side of the butt joint. Provide a 20mm gap between each keel and an 6mm gap between each decking board.

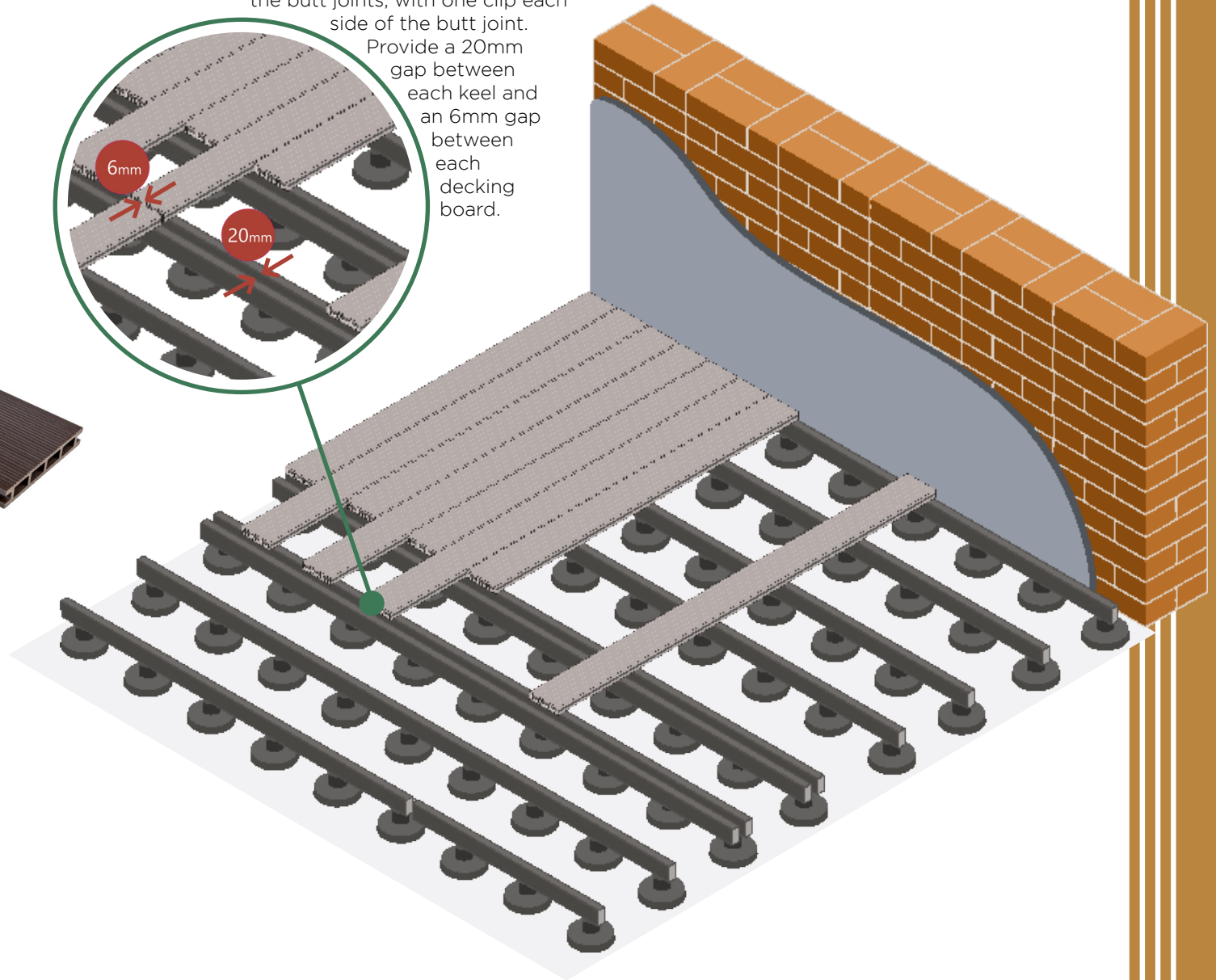
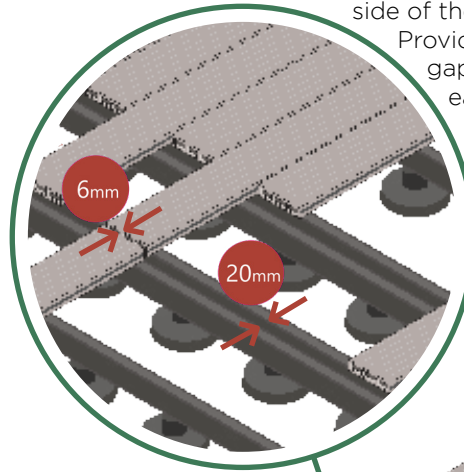

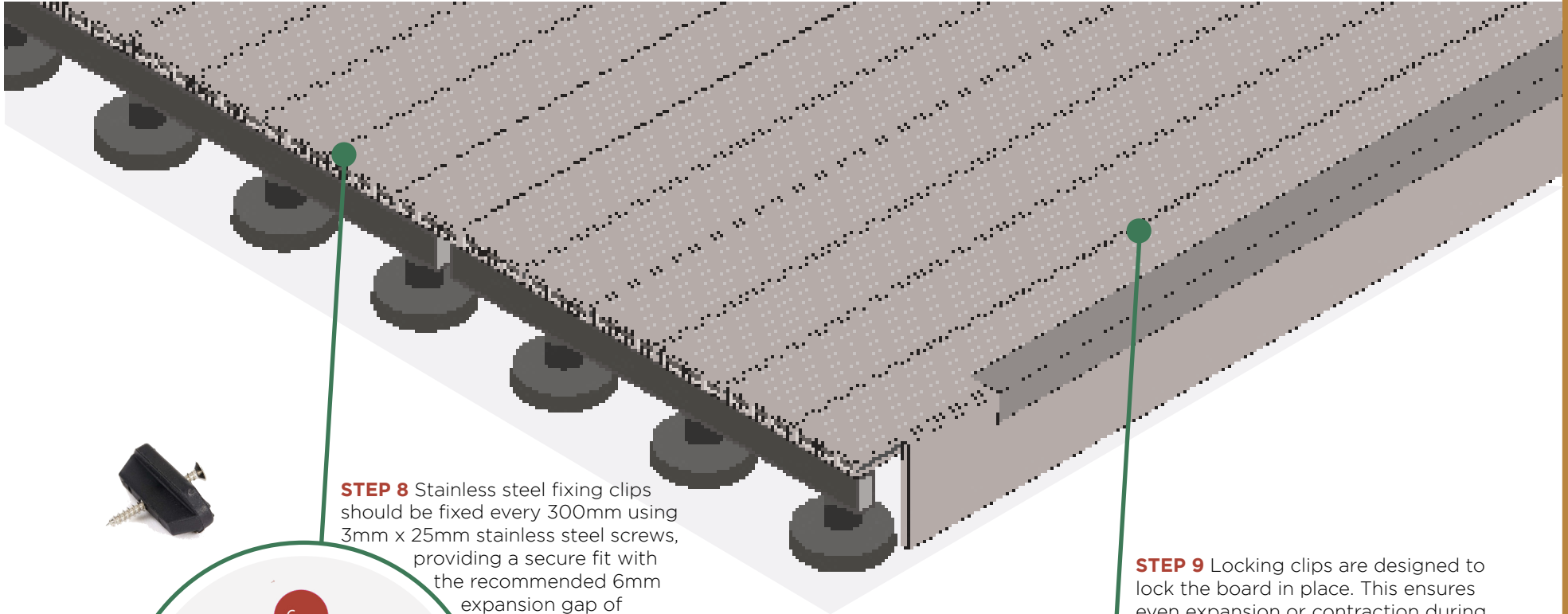

STEP 8 Stainless steel fixing clips should be fixed every 300mm using 3mm x 25mm stainless steel screws, providing a secure fit with the recommended 6mm expansion gap of decking boards.

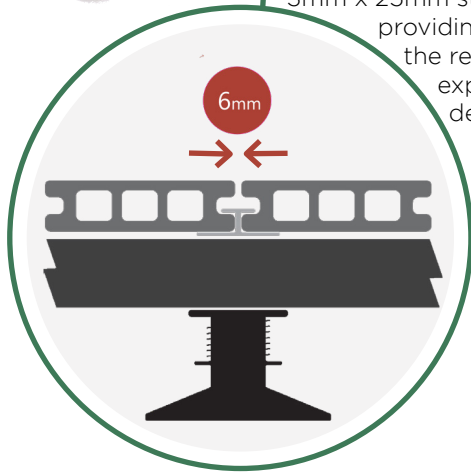

STEP 9 Locking clips are designed to lock the board in place. This ensures even expansion or contraction during hot or cold weather. One Locking clip can be placed to the centre of each board where it hits the keel. This will allow for the even expansion and contraction across the board length.

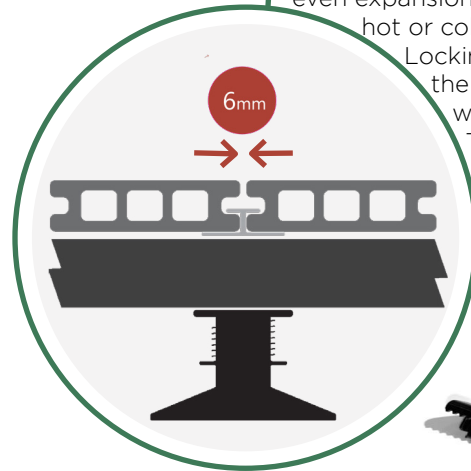

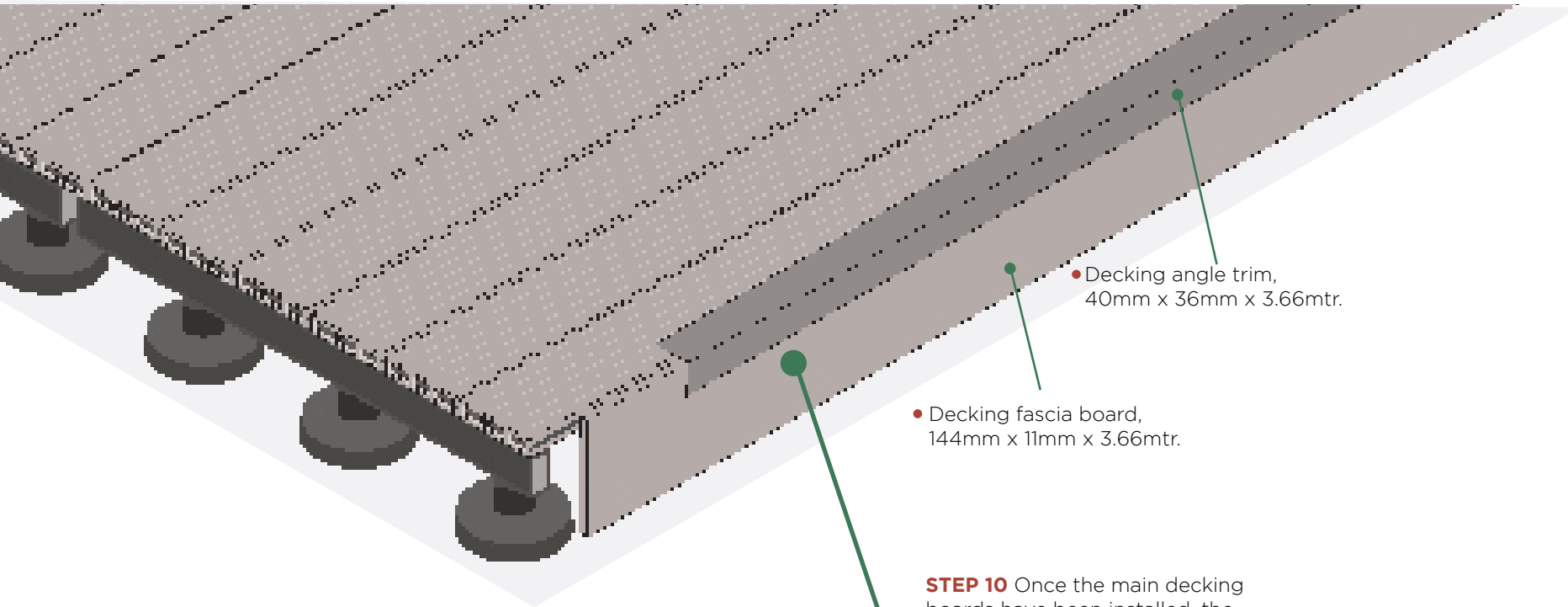

• Decking angle trim, 40mm x 36mm x 3.66mtr.

• Decking fascia board, 144mm x 11mm x 3.66mtr.

STEP 10 Once the main decking boards have been installed, the fascia trim and angle can be installed to create a clean edge.

Align the fascia with the top edge of the decking and fix into place using stainless steel screws.

Screws should be pre-drilled to avoid splitting.

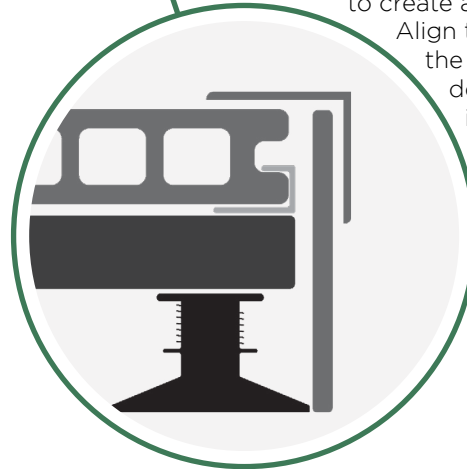

Installation complete.